

# INSTALLATION MANUAL

## System: KS06

Please read all instructions carefully before installation.

### Check List Before Installation:

- ✓ Test water for purity, unusual PH and/or acidic levels. Check with your local health department for test procedures.
- ✓ Test well draw down. KS series systems **CAN NOT** run dry. This will cause damage.
- ✓ Measure the diameter of the well casing to insure you have the proper size well seal. KS06 System requires a minimum 4" well casing inside diameter (ID).

### Tools Needed:

- Posthole Digger
- Adjustable Pliers
- Screwdrivers: Flat and Phillips
- Electrical Terminal Crimpers
- Knife
- Level
- Small awl or Drill bit
- Ratchet and sockets 3/8, 7/16, 1/2, 9/16
- Wrenches: 5/16, 7/16, 9/16
- Pipe Cutters

### Additional Items:

- 1-2 Bags of concrete approximately 80 lbs.
- 1 Gallon of Water
- 2-3/8IN OD SCH40 x 10FT LG Pipe
- Electrical Tape
- Well Seal to fit your well casing
- Down hole pipe properly sized for flow rate
- PVC Primer and Glue (when using PVC pipe)
- Fittings and Adapters for down hole pipe

### Specs:

Maximum Depth:	150 Feet or 65 PSI
Minimum Flow Rate at Max. Depth:	1.8 GPM
Maximum Flow Rate:	2.5 GPM

### System Products Included:

QTY	Part Number	Item Description
1	KC02	34V API Solar Panel with Mounting
1	535472-2	<a href="#">SR2 Brushless Solar Water Pump</a> , 100FT Wire
1	535812	<a href="#">Nylon Pre-Filter Kit</a>
0	135150	Wind Brace (Optional add on)
0	535681	On/Off Power Switch (Optional add on)
0	5351275	<a href="#">ALC 1275</a> (Optional add on)
1	KS06M	Manuals- also available online at <a href="http://solarpumps.com/resources/tech-docs">solarpumps.com/resources/tech-docs</a>

**Important Steps Before Installing & Troubleshooting on *page 4*.**

### Installing Your Solar Array-

1. Dig a hole using posthole diggers or shovel approximately 3 feet deep and 8-12 inches minimum in diameter near the well for 2-3/8IN OD x 10FT long. If there is an existing windmill, dig the hole approximately 4FT south of it. This will insure that no shadows from the windmill will fall across the face of the module.

**Tip:** The South, West, and East (North of Equator references) of the well to make sure there are no shadows from trees, etc. to cause a power loss. The solar array can be placed away from the well if required. Use larger gauge wire for longer distances.

2. Set the pole using quick setting concrete mixed with water to fill in the hole around the pole. Make sure the pole is plumb using a level. View illustration below.



FIGURE 2.A

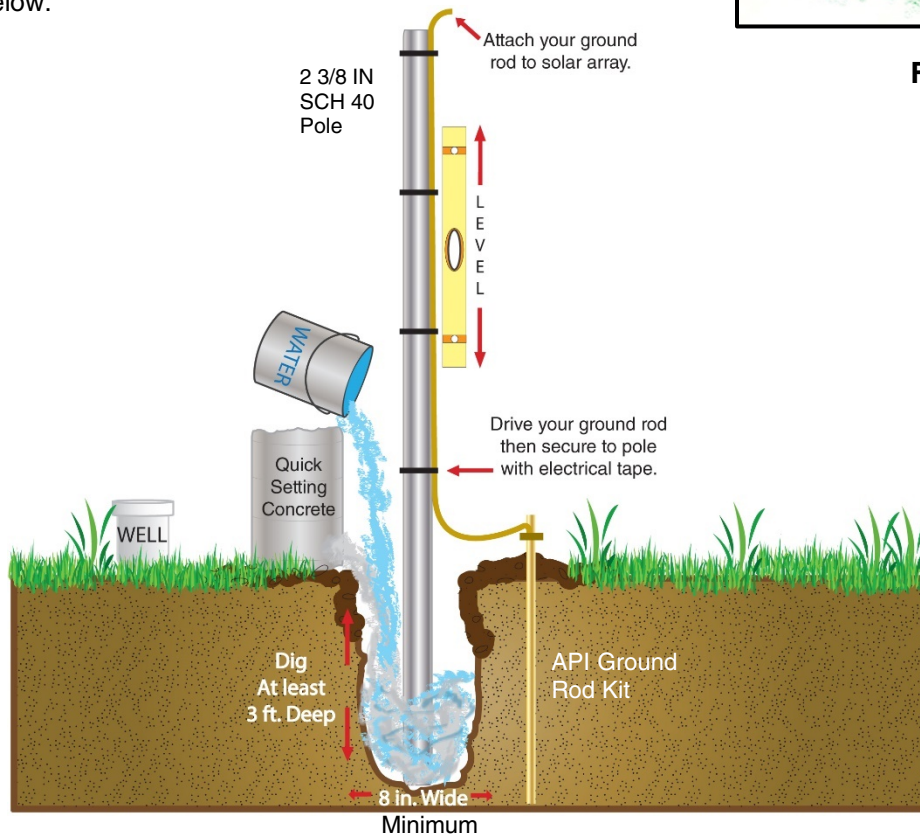

FIGURE 2.B

3. While your concrete and pole are drying, drive your *Ground Rod near the pole* (but not in the concrete) and prepare your pump to be installed.
4. Once, your pole is set and the **concrete is dried**; place your solar array with mounts on top of the pole. If your solar array did not come pre-assembled with mounts please view **FIGURE 3.A** for mount assembly first.
5. Adjust your solar array to face full midday sun and tighten set bolts & pivot bolt on tube mount with 9/16" wrench.  
*Note: When tightening the pivot bolt, do not spin the nut. Tighten the bolt head side and not the nut.*

# KS06 MOUNT ASSEMBLY

## Build of Materials for Pole Mounts-FIGURE 3.A

Legend	QTY	Part Number	Item Description
1	2	135175	Dual Panel Angle X 42IN
2	2	135174	Main Angle/3P Sub-Main 2IN X 2IN X 23.625IN
3	1	135105	2.5IN Pipe Mount
4	1	135150	**Wind Brace (Optional add on)
5	1	535827	**2.5IN U Bolt (Wind Brace add on)
6	1	535827	**2.5IN Clamp Bracket (Wind Brace add on)
7	2	538524	API Solar Panel (Check back of panel for specs)
8	8	915518	HHCS .25-20 X .75IN
9	2	915516	HHCS .375-16 X .5IN
10	1	915517	HHCS .375-16 X 4IN
11	2	915521	.375 Zinc Steel External Tooth Lock Washer
12	4	915515	SHCS .313-18 X .75IN
13	9	915519	Flange Nut .250 – 20IN
14	4	920042	Flange Nut .313 – 18IN
15	3	915550	Hex Nut .375 – 16IN Galvanized Grade 5 Nut
16	1	5351275	**ALC1275 Water Level Controller (Optional add on)
17	2	915525	**PHCS .25-20 X .625IN (Phillips Head) (ALC 1275 add on)

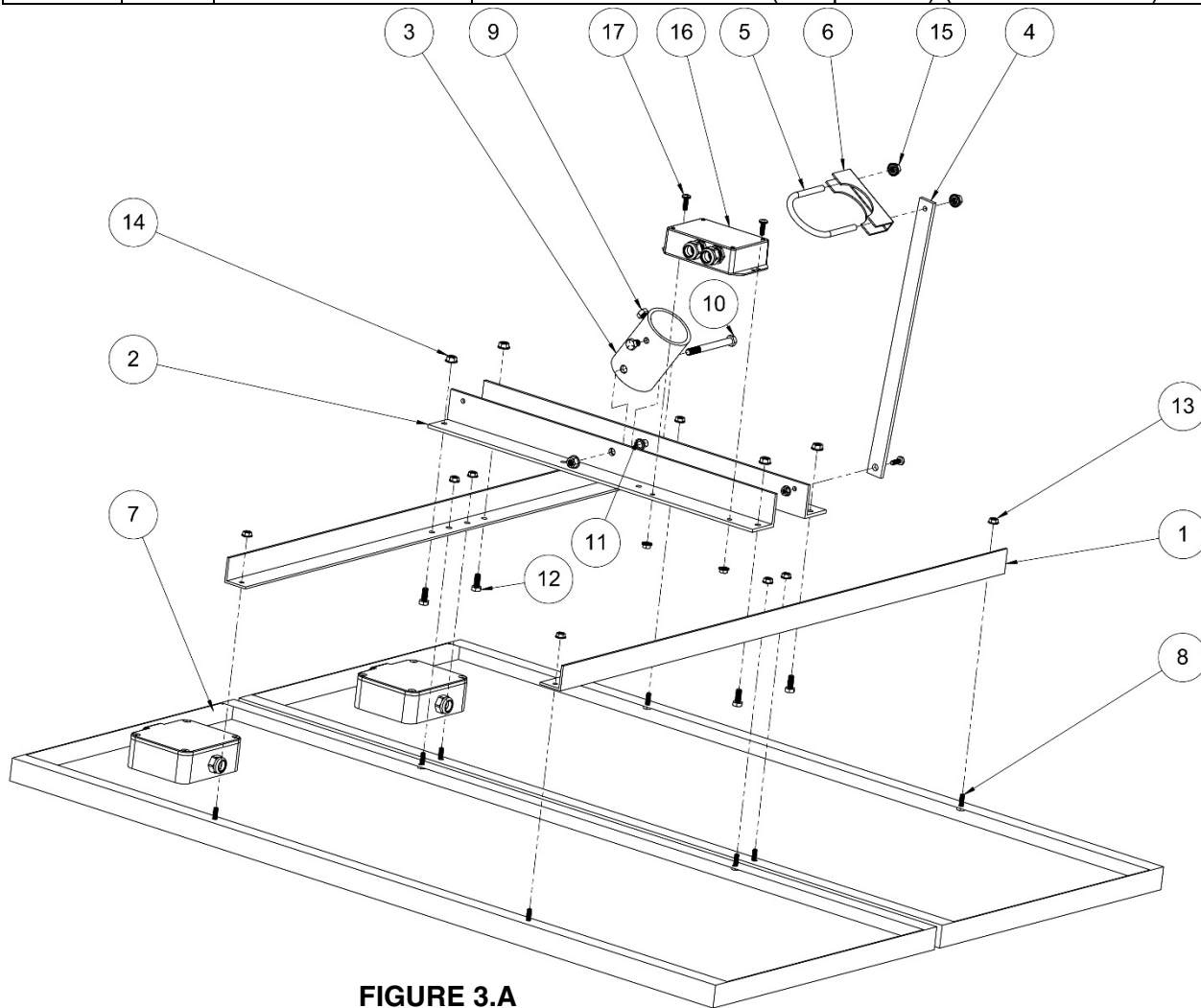

**FIGURE 3.A**

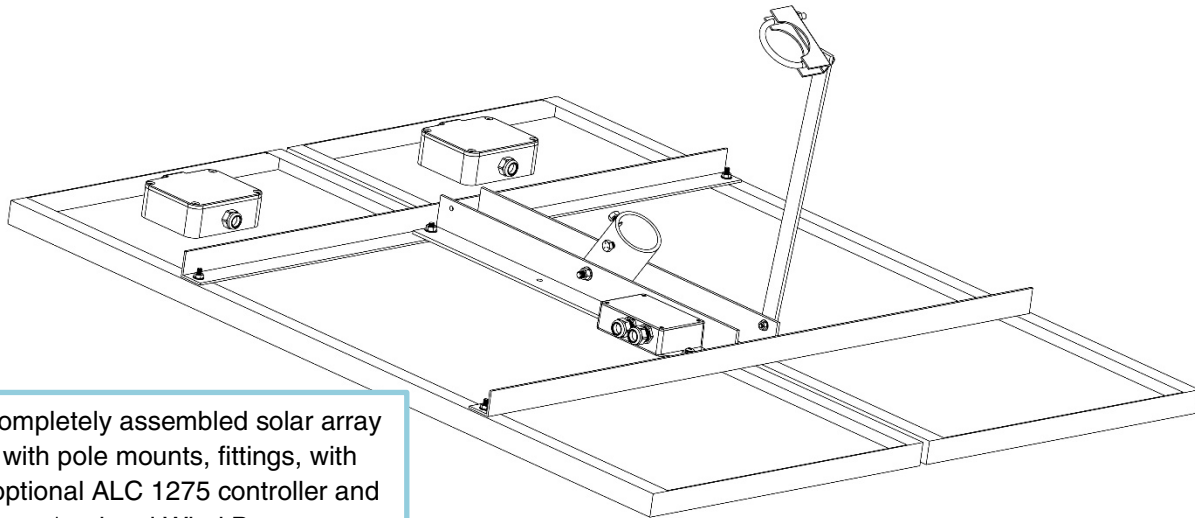

Completely assembled solar array with pole mounts, fittings, with \*optional ALC 1275 controller and \*optional Wind Brace.

FIGURE 4.A

## TROUBLE SHOOTING

**If you experience issues while installing your product or trouble shooting, please contact our technicians so we can assist you.**

- Check the solar module for any damages.
- Check for Shadows, there should be no shadows falling across the face of the module at any time during the day whether permanent or temporary.
- Check the direction on how the solar module faces, it should be pointed at the Sun during mid-day or peak sunlight hours.
- Check the wiring and connections. Confirm there is no damage to exterior jacket or internal pins of connections. Open the junction box(es) on the solar module(s) to confirm tight connections.
- If you have a multimeter available, please check voltage and amperage from solar right during the brightness of sunlight- typically midday. Confirm these readings match the data label on the back of the solar module.

### **Important Steps When Installing:**

- No additional controller is required for API solar water pumps, however the ALC 1275 water level controller greatly increases the life expectancy of our solar pumps and prevents unnecessary wear and tear on the pump.
- Please be sure your well has been tested for flow rate and continuous flow supply. In order to reach these water demands, your well must be able to keep up with the solar pump. Otherwise, damages can occur.
- Please check for the correct tilt angle for the geographical location where the system will be installed. Reference on how to calculate azimuth angle for solar panels <https://www.esrl.noaa.gov/gmd/grad/solcalc/>
- If needed adjust the solar array 2 to 4 times per year to match the sun. If not, a higher degree of angle will help shed large hail stones and decrease likely hood of damage.
- Do you have wind turbines within 1/2 mile of your solar pump system? Find out why your system can become damaged by speaking with one of our system specialists.
- Don't forget to prep your system for the winter!! Drain or weep holes are a must!
- Ground Rods help to preventing damage from lightening spikes; we highly recommend installing a ground rod for your solar systems.
- See Pump Manual for plug connector illustrations. Be certain of plug connector alignment, do not force, damage may occur.

**View our [website](#) for video installs, quick tips and more!**